

### Surface Mount Schottky Barrier Diodes

**(Pb)** Lead(Pb)-Free

#### Feature:

- \*Extremely High Switching Speed.
- \*Low Forward Voltage and Low Reverse Current.
- \*High Reliability.
- \*Schottky Barrier Diodes Encapsulated in a SOD-523 Package

#### Description:

These schottky barrier diodes are designed for high speed switching applications circuit protection, and voltage clamping, Extremely low forward voltage reduces conduction loss, Miniature surface mount package is excellent for hand held and portable applications where space is limited.

**SMALL SIGNAL  
SCHOTTKY DIODES  
200m AMPERES  
40 VOLTS**

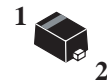

**SOD-523**

### SOD-523 Outline Dimensions

Unit:mm

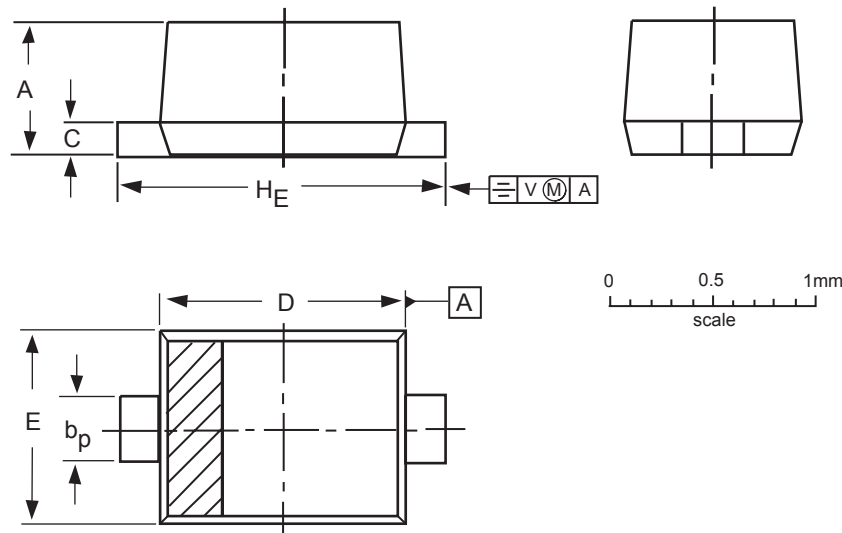

#### DIMENSIONS (mm are the original dimensions)

UNIT		A	b <sub>p</sub>	c	D	E	H <sub>E</sub>	V
mm	max	0.7	0.35	0.2	1.3	0.9	1.7	0.15
	min	0.5	0.25	0.1	1.1	0.7	1.5	

Note1. The marking bar indicates the cathode.

OUTLINE VERSION	REFERENCES			EUROPEAN PROJECTION	ISSUE DATE
	IEC	JEDEC	EIAJ		
SOD-523			SC-79		98-11-25

**Maximum Ratings** ( $T_A=25^{\circ}\text{C}$  Unless otherwise noted)

Characteristic	Symbol	Value	Unit
Reverse Voltage	$V_R$	40	V
Average Rectifier Forward Current	$I_{F(AV)}$	200	mA
Peak Forward Surge Current <sup>(1)</sup>	$I_{FSM}$	1.0	A
Operating Junction Temperature Range	$T_J$	125	$^{\circ}\text{C}$
Storage Temperature Range	$T_{stg}$	-40 to +125	$^{\circ}\text{C}$

**Electrical Characteristics** ( $T_A=25^{\circ}\text{C}$  Unless otherwise noted)

Characteristic	Symbol	Min	Max	Unit
Reverse Breakdown Voltage $I_R = 100\mu\text{A}$	$V_{(BR)R}$	40	-	V
Forward Voltage $I_F = 10\text{mA}$	$V_F$	-	0.39	V
Reverse Leakage $V_R = 10\text{V}$	$I_R$	-	1.0	$\mu\text{A}$

NOTE: 1. 60HZ for 1 $\varnothing$ **Device Marking**

Item	Marking	Equivalent Circuitdiagram
WSD520S-40	D	1  2

## Electrical characteristic curves

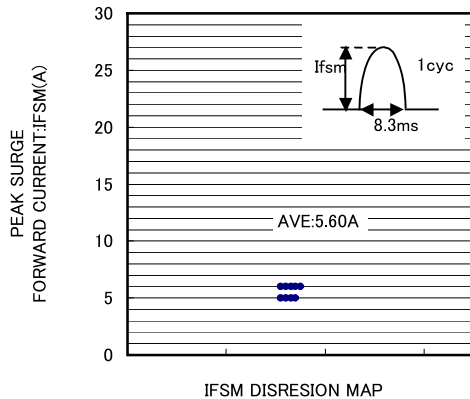
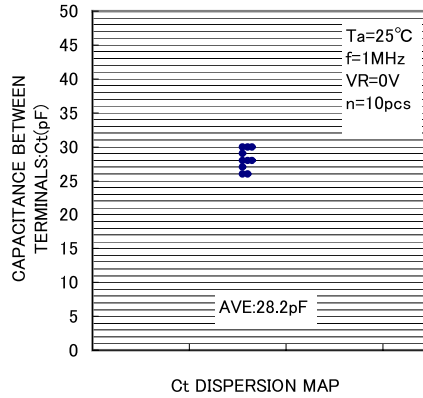
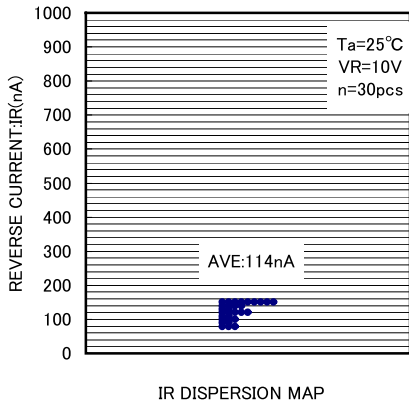
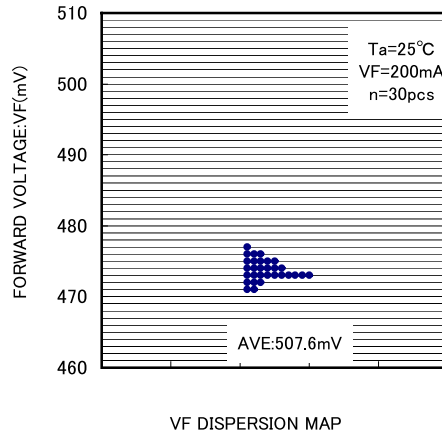
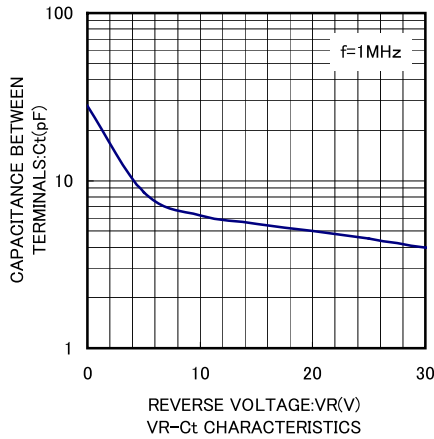
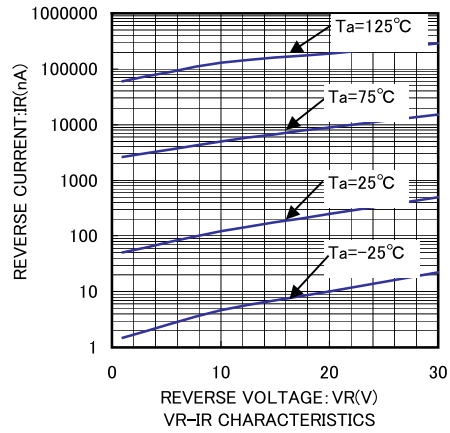
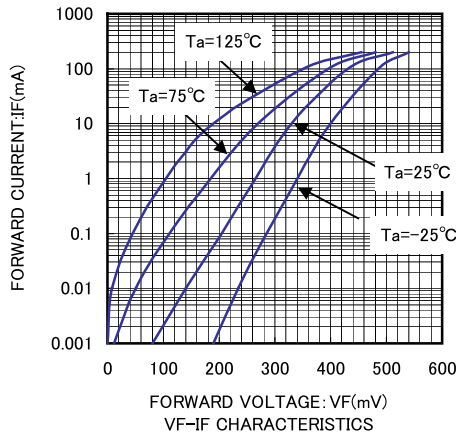

## Electrical characteristic curves (Ta=25°C)

